

SPECIFICATION

SS-150D Series LED Driver

Model: SS-150D-XX

Description: 150W LED DRIVER

Rev.: V03

Release Date: 2018-07-04



SHENZHEN SOSEN ELECTRONICS CO.,LTD

A3 Building, Gonghe Fourth Industrial Area, Shajing Street, Baoan District
Shenzhen, China 518104

Features

- Efficiency up to 93%
- Optional dimming function: 0-10V, PWM, Resistor, Timing
- IP65 rated
- Protections: SCP, OTP, OVP
- Metal case with full potted for hazardous scenarios
- Surge Protection: L/N-PE: 4kV, L-N: 4kV
- 5 years warranty



Description

SS-150D series are constant current LED driver with input voltage 90-305Vac and high power factor. They are specifically designed for LED luminaries such as high bay, with low standby power, high efficiency, compact housing and good thermal management, which greatly enhance the reliability and lifespan. Comprehensive protections, including Over Voltage Protection, Short Circuit Protection and Over Temperature Protection, ensure proper functioning.

Model List

Model	O/P Voltage	O/P Current	Max. O/P Power	O/P Current Tolerance	THD (Typ.)	PF (Typ.)	Efficiency (Typ.)
SS-150D-38*	24-38V	2.0-4.7A	150W	±5%	8%	0.95	92%
SS-150D-54*	27-54V	1.4-3.6A	150W	±5%	8%	0.95	93%
SS-150D-68*	42-68V	1.1-2.7A	150W	±5%	8%	0.95	93%

Note:

1. Default Tested at 230Vac, full load, Ta 25°C.
2. Optional B, T or space in the place of * means additional function.

Space is the base model without any optional function;

- Suffix B for model with 3-in-1 dimming (0-10V, PWM, Resistor);
- Suffix T for model with timing control.

Input Characteristics

Parameter	Min	Typ.	Max	Remarks
Rated AC input range	100Vac		277Vac	Derated @ 100-200Vac, see Fig. 7
AC input range	90Vac		305Vac	
Input frequency range	47Hz		63Hz	
Max input current			1.6A	90Vac, 70% load
Inrush current			60A	Cold start , 230Vac/50Hz , Twidth=650us measured at 50% Ipeak
No load power		3W	5W	277Vac/50Hz, no load
Power factor	0.93	0.95		230Vac/50Hz, full load
	0.9			100-277Vac/50Hz, 70-100% Load
THD		8%	10%	230Vac/50Hz, full load
			20%	100-277Vac/50Hz, 70-100% Load

Output Characteristics

Parameter	Min	Typ.	Max	Remarks
Output voltage range	SS-150D-38*	24V	38V	Power derated @ 24-32Vdc, see Fig. 1
	SS-150D-54*	27V	54V	Power derated @ 27-42Vdc, see Fig. 1
	SS-150D-68*	42V	68V	Power derated @ 42-56Vdc, see Fig. 1
Rated output voltage	SS-150D-38*	32V	38V	Po=Vo*Io=150W, full load, see Fig. 1
	SS-150D-54*	42V	54V	
	SS-150D-68*	56V	68V	
Rated output current	SS-150D-38*	3.95A	4.7A	4.7A for32V, 3.95A for 38V
	SS-150D-54*	2.75A	3.6A	3.6A for 42V, 2.75A for 54V
	SS-150D-68*	2.2A	2.7A	2.7A for56V, 2.2Afor 68V
Current adjustable range	SS-150D-38*	2.0A	4.7A	Rated Io 50%-100% adjustable
	SS-150D-54*	1.4A	3.6A	
	SS-150D-68*	1.1A	2.7A	
No load voltage	SS-150D-38*	38.5V	39.5V	40V
	SS-150D-54*	54.5V	55.5V	56V
	SS-150D-68*	68.5V	69.5V	70V
Efficiency @230Vac	SS-150D-38*	90%	92%	38Vdc/3.95A, see fig. 5
	SS-150D-54*	91%	93%	54Vdc/2.75A, see fig. 5
	SS-150D-68*	91%	93%	68Vdc/2.2A, see fig. 5
Output current tolerance	-5%		+5%	



Output voltage ripple(PK-PK)		1%	2%	Full load
Output current ripple (PK-PK)		5%	10%	Full load
Start-up current overshoot			10%	
Start-up time		0.6S	1S	115Vac
		0.4S	0.5S	230Vac
Line Regulation	-2%		+2%	Full load
Load Regulation	-2%		+2%	

Other Characteristics

Parameter		Min	Typ.	Max	Remarks
0-10V Dimming (Optional)	Dim Vmax	0V		14V	3 in 1 Dimming; 0-5V Dimming Optional; Negative Logic Dim Optional; Dim-off(Optional, contact SOSEN for more details)
	Dim Range	10%Iomax		100%Iolet	
	Voltage	1V		10V	
PWM Dimming (Optional)	High	5V		10V	
	Low	-0.3V		-0.6V	
	Frequency	200Hz		2KHz	
	PWM Duty	1%		99%	
Resistor Dimming (Optional)	Resistance	10K ohm		100K ohm	
	Dimming	10%Iomax		100%Iolet	
Timing Curve (Optional)	IC Control	By programming			Typically 3-4 sections
	Timing	5H/6H/7H/8H per section			Default Mode: 24Hour/Circle with 50% load
Protection	OTP	90°C	100°C	110°C	Tc, Self-recovery
	Short Circuit Protection	Driver will not damaged with short-circuit power <10W			Hiccup mode
Life time			55,000hrs		230Vac, full load, Tc 75°C, See Fig. 6
MTBF			200,000hrs		230Vac, full load, Ta= 25°C, (MIL-HDBK-217F)
Temperature Coefficient	-0.03%/°C			+0.03%/°C	Tc : 0°C~85°C
Tc				85°C	
Warranty			5 years		Tc : 75°C
Net Weight			1500g		
Dimension	Φ151mm*71mm				D x H

NOTE: All the parameters above are tested Ta 25°C, unless specified.

Environmental Requirements

Parameter	Min	Typ.	Max	Remarks
Operating Temperature	-40℃	25℃	+60℃	See Fig. 2
Storage Temperature	-40℃	25℃	+85℃	
Operation Humidity	10%RH		90%RH	
Storage Humidity	5%RH		95%RH	
Altitude	-65m		4,000m	
Cooling Method	Air Cooling			

Safety and EMI/EMS Standards

Certification	Standard	Status	Remark
TUV	EN 61347-2-13:2014 EN61347-1:2008+A1:2011+A2:2013 EN62493:2010	√	
SAA	AS/NZS61347.2.13	√	
CCC	GB 19510.14-2009	√	
CE	EN 61347-2-13:2014 EN61347-1:2008+A1:2011+A2:2013	√	

Item	Standard	Remark
Insulation strength	Input-output	3200Vac/5mA Max/60s
	Primary-Earth	1600Vac/5mA Max/60s
	Sec.- Earth	1000Vac/5mA Max/60s
Insulation resistance	Input-output	≥10MΩ
Ground resistor	≤0.1Ω	25A/1min
Leakage current	≤0.75mA	277Vac
Item	Criterion	Remark
Conduction Emission	EN55015:2013+A1:2015	
Radiation Emission	EN55015:2013+A1:2015	
Harmonic Current Emissions	IEC/EN 61000-3-2	Class C
Surge	IEC/EN61000-4-5	Difference mode 4kV, Common mode 4kV Criterion B

NOTE: SOSEN warrants the LED Driver itself complys with EMC standard. However, LED Driver's EMC should be re-checked when integrated into lighting systems due to unexpected interference as component.

Performance Curves

Fig. 1 O/P Voltage VS Output Current

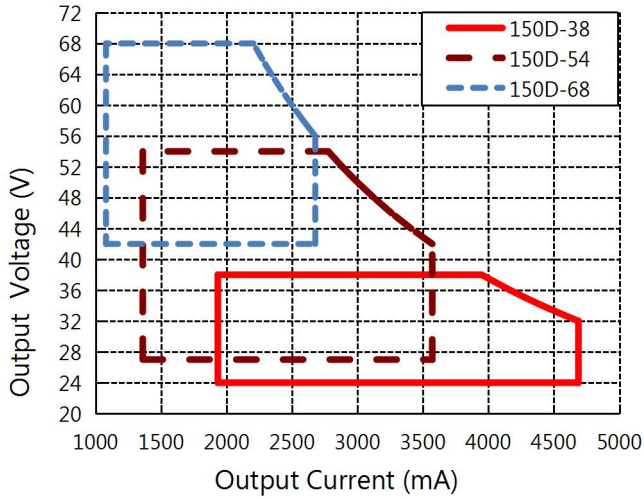

Fig. 2 O/P Power VS Ambient Temperature

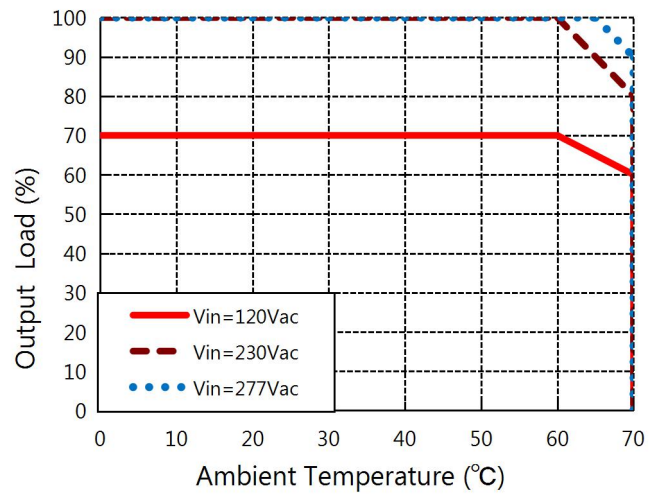

Fig. 3 Power Factor VS Output Power

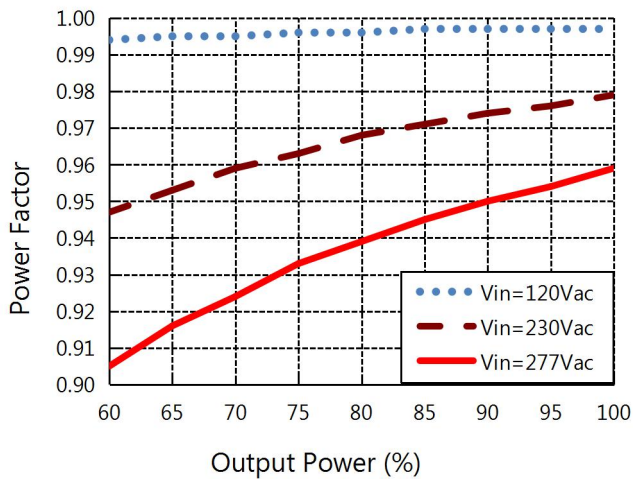

Fig. 4 THD VS Output Power

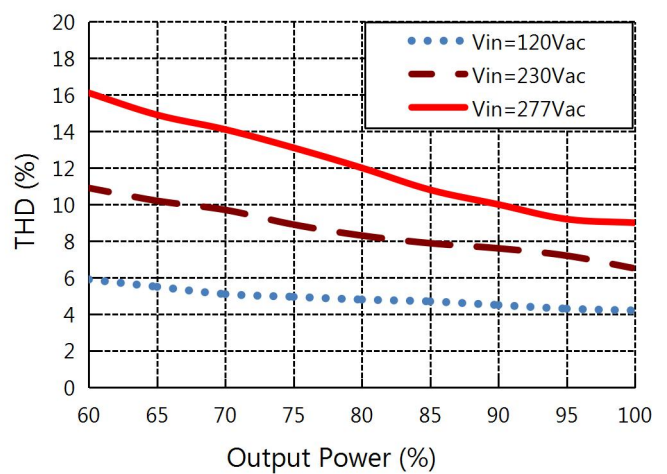

Fig. 5 Efficiency VS Output Power

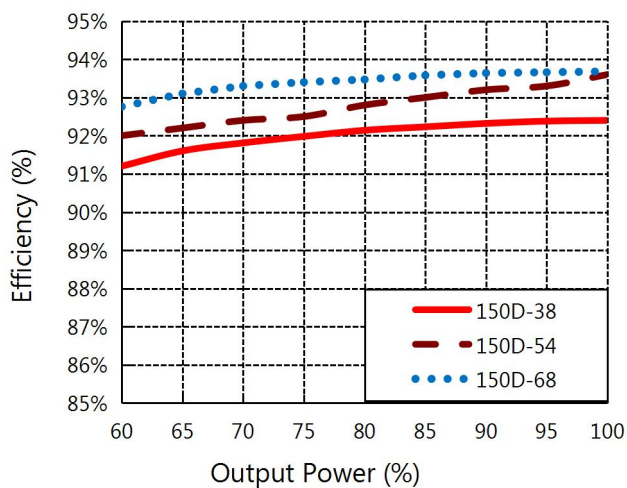

Fig. 6 Lifespan VS Case Temperature

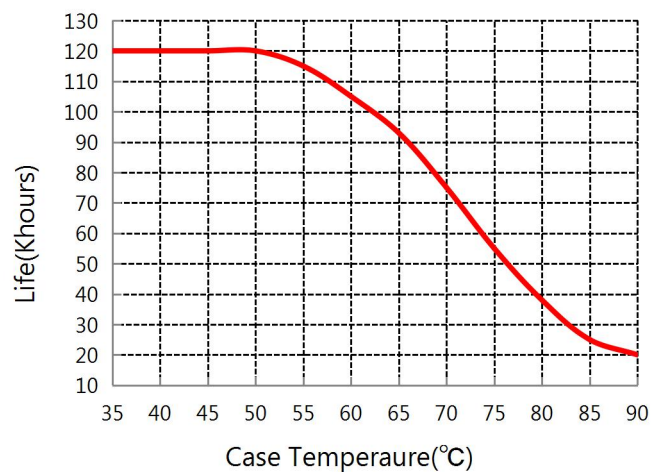
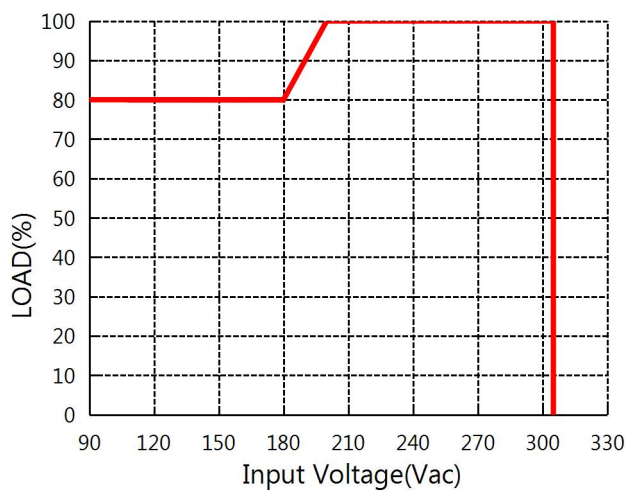
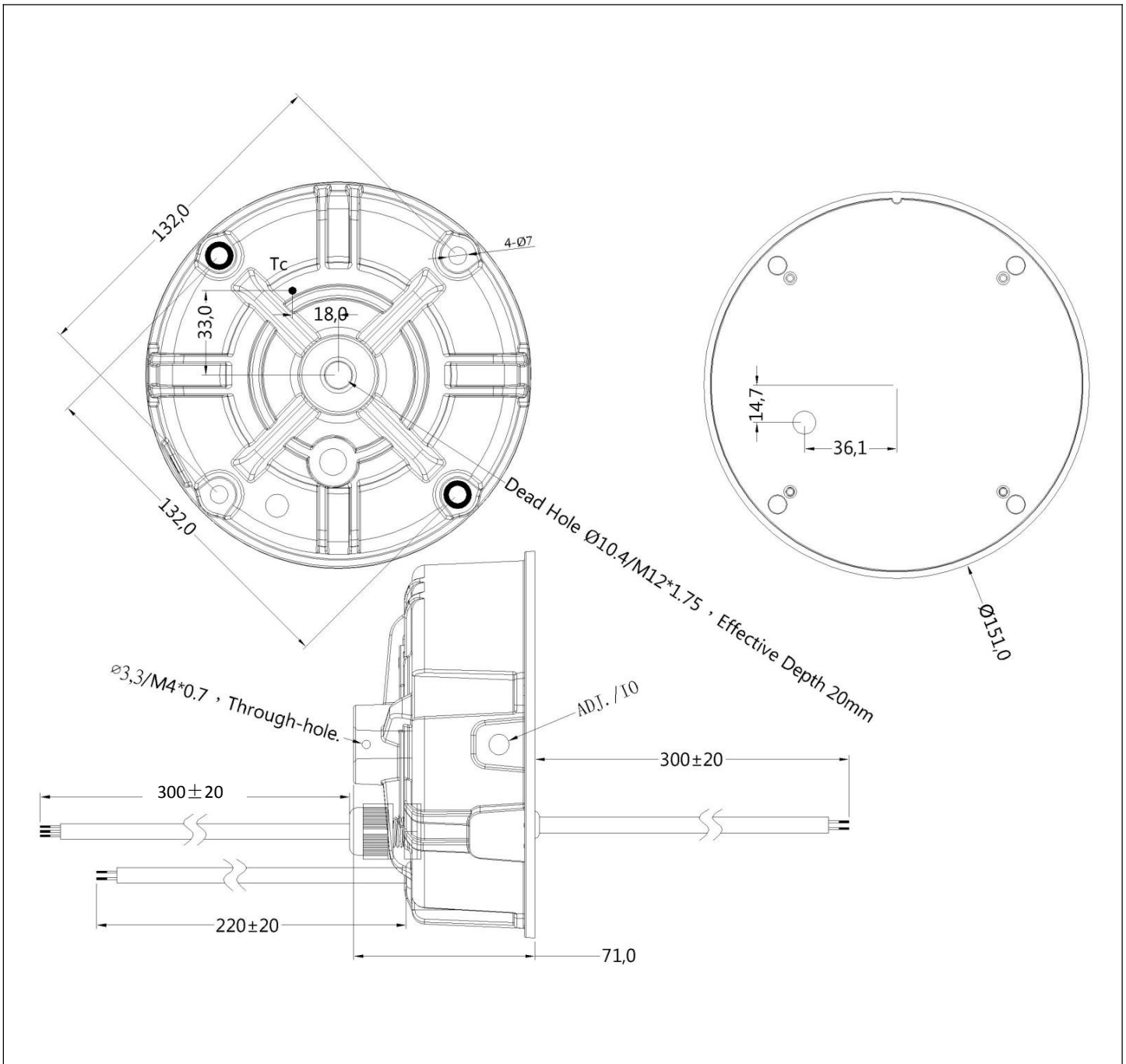

Fig.7 Output Power VS Input Voltage



Mechanical Characteristics (Unit: mm)



NOTE:

Input Wire	VDE H05RN-F 3*1.0 mm ² , O.D: 7.4mm, BROWN: L, BLUE: N, YELLOW/GREEN: PE
Output Wire	VDE H05RN-F 2*1.0 mm ² , O.D: 7.0mm, BROWN: V+, BLUE: V-
Suffix B DIM	STYLE 2733 #22AWG O.D: 5.8mm, PURPLE: DIM+, GRAY: DIM-

Labels

TUV/SAA/CE	
<p>○ ACL---BROWN</p> <p>○ ACN---BLUE</p> <p>○ ---GREEN/YELLOW</p> <p>MADE IN CHINA</p> <p>HTTP://www.szsosen.com</p>	<div style="text-align: center;"> MODEL:SS-150D-38B SOSEN LED Driver </div> <hr/> <p>Manufacturer: Shenzhen Sosen Electronics Co.,Ltd A3 building, Gonghe Fourth Industrial Area, Shajing Street, Baoan District, 518104 Shenzhen, PEOPLE'S REPUBLIC OF CHINA INPUT: 100-277V~ Max.1.6A 50/60Hz PF≥0.95</p> <p>OUTPUT: 24-38V== 2.0-4.7A Max.40V== Max.150W(Input:200-277V~) 24-38V== 2.0-3.3A Max.40V== Max.105W(Input:100-200V~)</p> <p>Suitable for Dry, Damp and Wet Locations For LED modules use only</p> <div style="display: flex; justify-content: space-around; align-items: center;"> RoHS SELV </div>
CCC	
<p>○ ACL---BROWN(棕)</p> <p>○ ACN---BLUE(蓝)</p> <p>○ ---GREEN/YELLOW(绿/黄)</p> <p>HTTP://www.szsosen.com</p> <p>MADE IN CHINA 制造地:中国</p>	<div style="display: flex; justify-content: space-between;"> <div style="writing-mode: vertical-rl; transform: rotate(180deg);">INPUT (输入端)</div> <div style="text-align: center;"> MODEL(型号):SS-150D-38B SOSEN LED DRIVER(LED模块用交流电子控制装置) </div> <div style="writing-mode: vertical-rl; transform: rotate(180deg);">OUTPUT (输出端)</div> </div> <hr/> <p>Manufacturer: Shenzhen City Sosen Electronics Co.,Ltd 制造商: 深圳市松盛电子股份有限公司 INPUT(输入):100-240V~ 1.6A 50/60Hz PF≥0.95 277V~ 0.8A 50/60Hz (277V~只适用于北美)</p> <p>OUTPUT(输出): 24-38V== 2.0-4.7A Max.40V 输出功率:150W(Input:200-240V~,277V~) 24-38V== 2.0-3.3A Max.40V 输出功率:105W(Input:100-200V~(LED模块))</p> <div style="display: flex; justify-content: space-around; align-items: center;"> RoHS SELV </div>

Dimming Diagram



- Output current could be adjusted by connecting 0-10V or PWM signal between DIM+ and DIM-
- DO **NOT** connect DIM- and V- to avoid abnormal output

0-10V Dimming (Typ.), See Fig. 8

Voltage Range	1V	2V	3V	4V	5V	6V	7V	8V	9V	10V	OPEN
Rated current percentage	10%	20%	30%	40%	50%	60%	70%	80%	90%	100%	95%-108%

10V PWM frequency range (Typ.): 200Hz-2KHz, See Fig. 9

PWM duty	10%	20%	30%	40%	50%	60%	70%	80%	90%	100%	OPEN
Rated current percentage	10%	20%	30%	40%	50%	60%	70%	80%	90%	100%	95%-108%

Resistor(Typ.), N represents the number of power supplies

Resistor	10KΩ	20KΩ	30KΩ	40KΩ	50KΩ	60KΩ	70KΩ	80KΩ	90KΩ	100KΩ	OPEN
	/N	/N	/N	/N	/N	/N	/N	/N	/N	/N	
Rated current percentage	10%	20%	30%	40%	50%	60%	70%	80%	90%	100%	95%-108%

Fig. 8 0-10V Dimming Curve

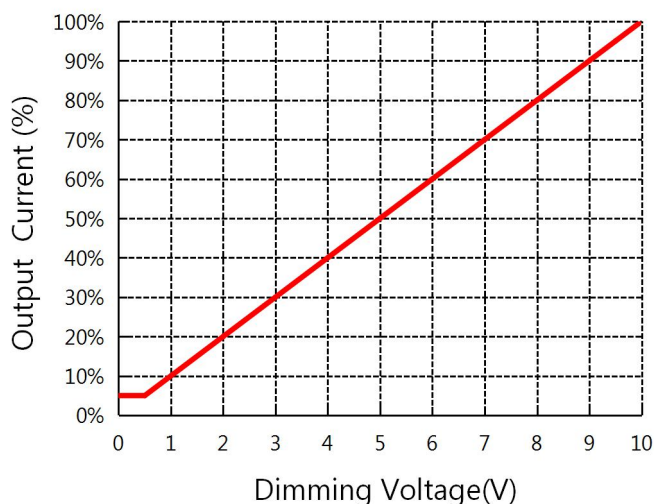
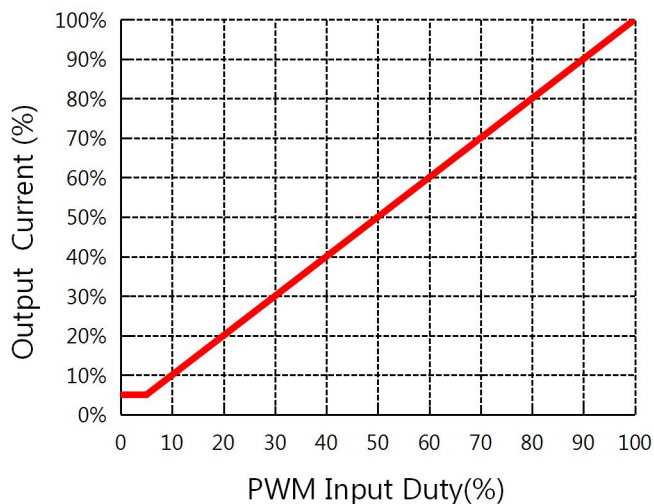

Fig. 9 PWM Dimming Curve



Installation Tips

1. Highly recommended to seal the adjustable hole with silicon glue (#704 preferred) after adjusting the driver's output current. Torsion with proper strength to avoid permanent damage to the potentiometer inside.
2. Pls confirm the integrity of the product if the package is broken when you receive goods, and the crack is not allowed on the outside of the driver's structure.
3. The screw thread need to meet the length of 15-22mm and integrate to the thread hole of the driver tightly and firmly and make sure all the screws and ring are locked firmly.
4. Whole luminaire's wight should be less than 13kg with the driver(1.5kg).
5. Dimming leads should be capped if not in use to avoid dimming circuit damage caused by external signals.

Package, Transportation & Storage

1. Package

- Outside carton dimension: L×W×H =500mm×390mm×170mm;
- 10PCS/Carton;
- Net weight/PC: 1.5kg;
- Gross weight/Carton: 16kg.

2. Transportation

Packaging is designed suitable for transportation by trucks, vessels and flights. The products should be shielded from direct sunshine, loaded/unloaded with caution.

3. Storage

The product storage meets the standard of the GB 3873—83.

Products should be rechecked if stock for over 1 year before installation.